



Transform a 4GL GUI into a Modern Web Application Without a Rewrite

**Greg Shah, CEO
Golden Code Development**

**Thursday October 11, 2018
www.beyondabl.com**

Agenda

- UI Paradigm Evolution
- Conventional Modernization
- FWD
- Running 4GL GUI as Web UI
- Enhanced 4GL Capabilities
- Customer Demonstration and Testimonial
- Status

UI Paradigm Evolution

UI Paradigm Evolution

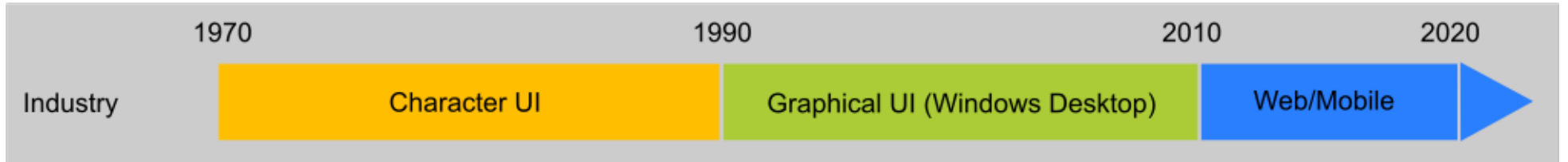

UI Paradigm Evolution

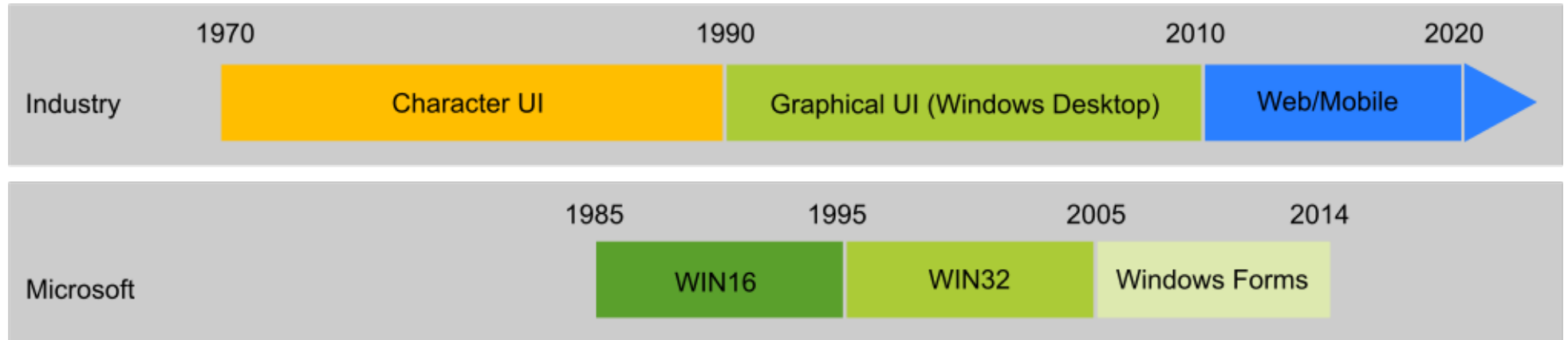

UI Paradigm Evolution

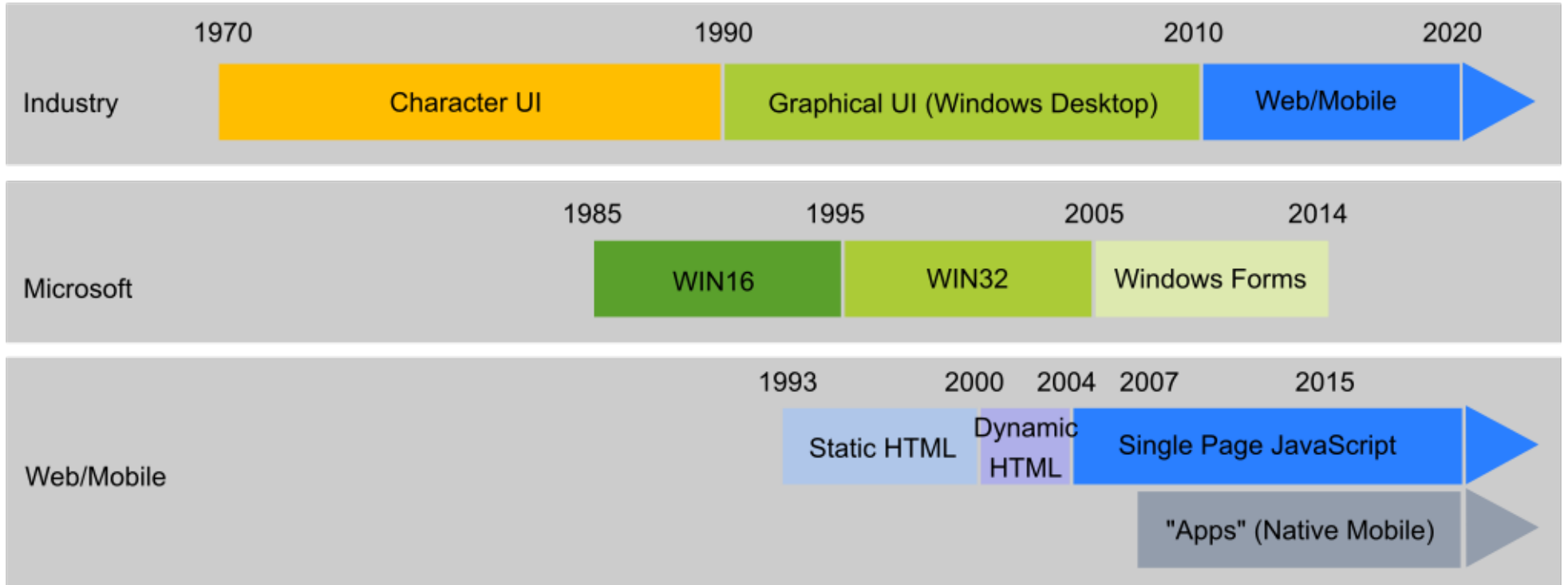

UI Paradigm Evolution

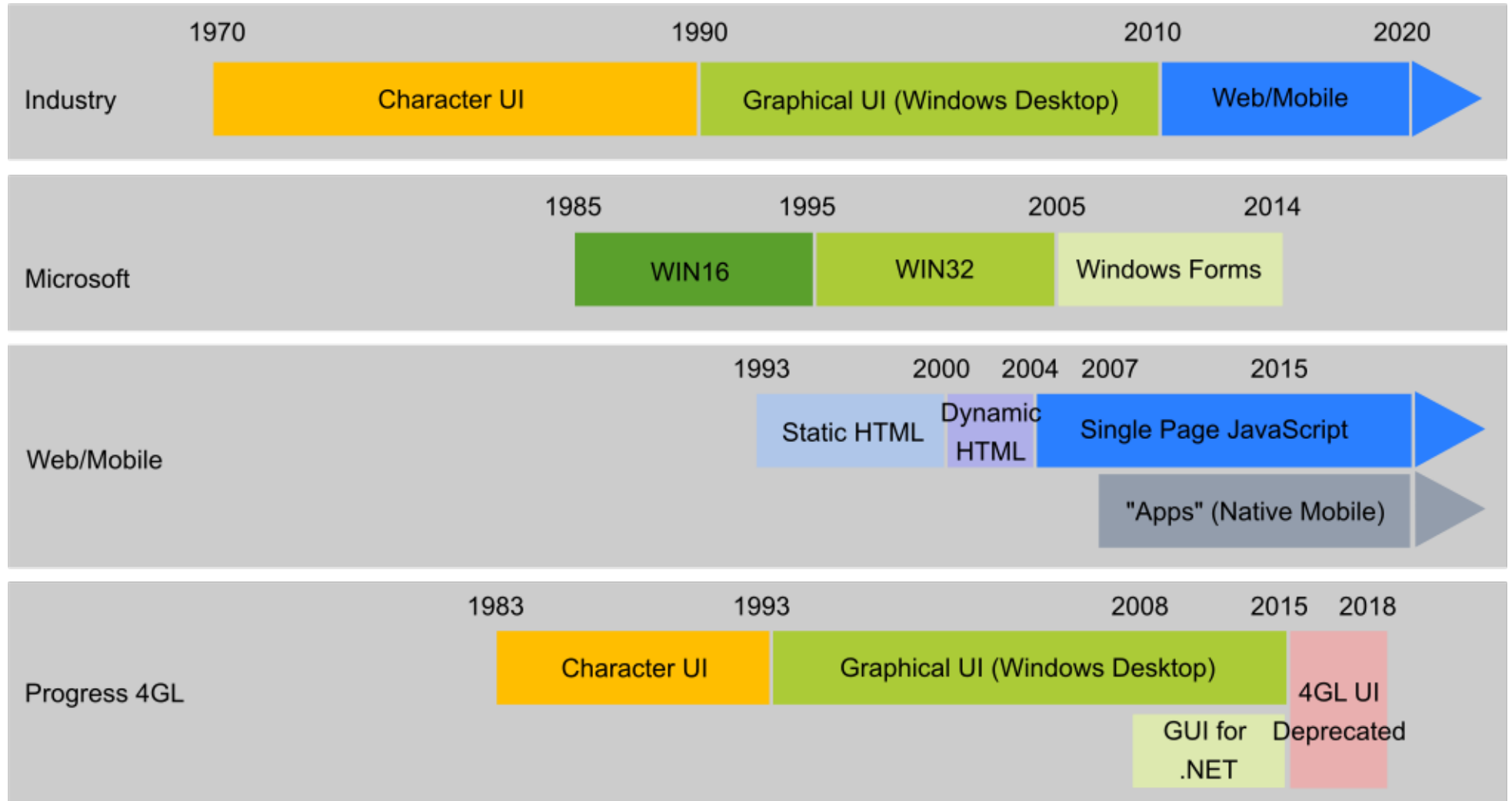

Strategic Assessment

- Web/Mobile is the strategic UI paradigm
- The shift away from desktop applications occurred between 2007 and 2011
- In 2017, “green field” business software is NOT written using Windows GUI APIs, including Windows Forms (i.e. OpenEdge GUI for .NET)
- Windows Forms is not strategic, *even for Microsoft*; placed in maintenance mode in 2014
- OpenEdge GUI for .NET is an evolutionary dead end
- Moving to web and mobile should be a high priority for all business software
- Disparity between 1990’s style WIN32 GUI and modern UI paradigms driving UI Modernization

Conventional Modernization

Conventional Modernization

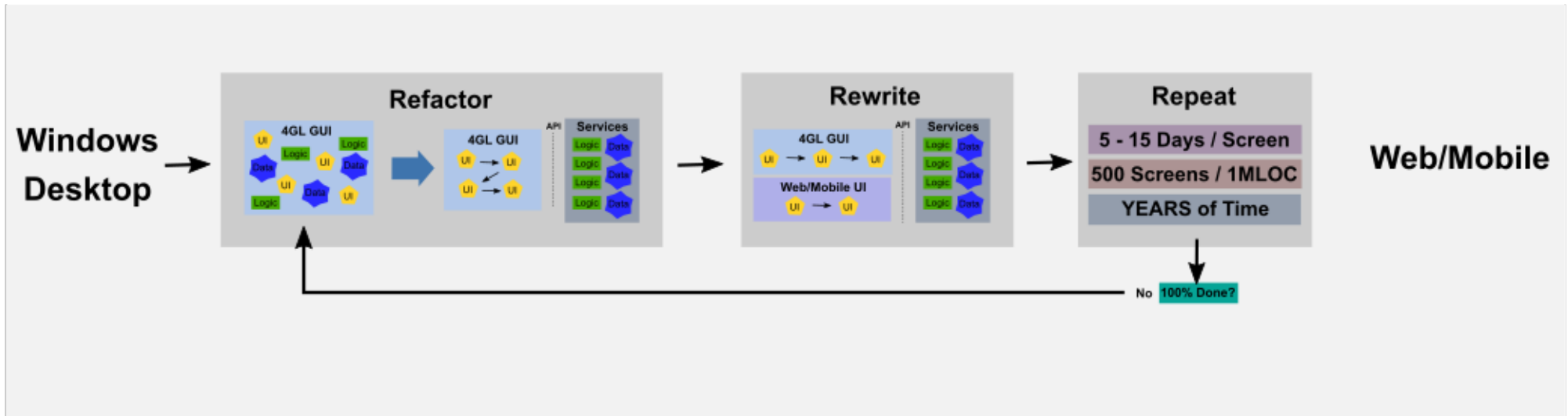

The Long Tail

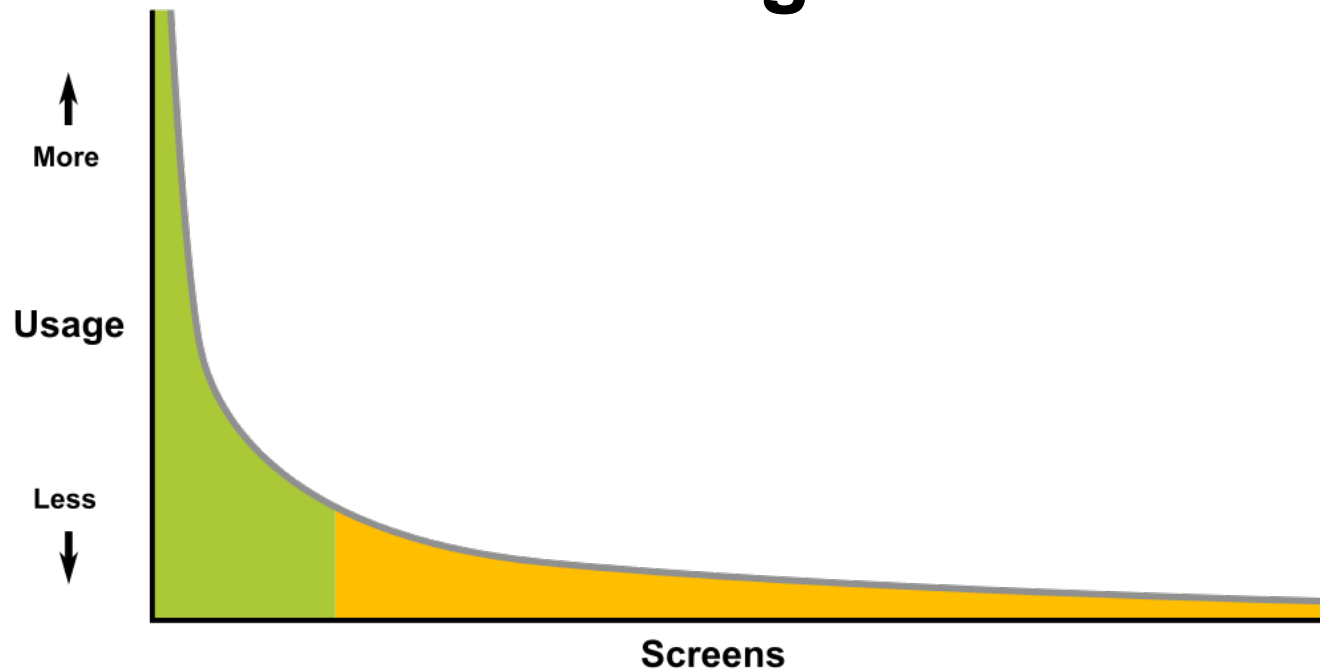

- Each dialog/window/ADM[2] tab is considered a “screen”
- Non-trivial applications have surprisingly large number of screens; empirical experience suggests at least 500 screens per 1MLOC of code*
- Most (~90%) of application’s high value features done with ~10% of screens
- On average, cost and effort to rewrite a low value screen is same as to rewrite a high value screen
- Return on investment for ~90% of screens never achieved

* FWD Code Analytics can be used to get an exact number, no matter how large the project.

Conventional Modernization

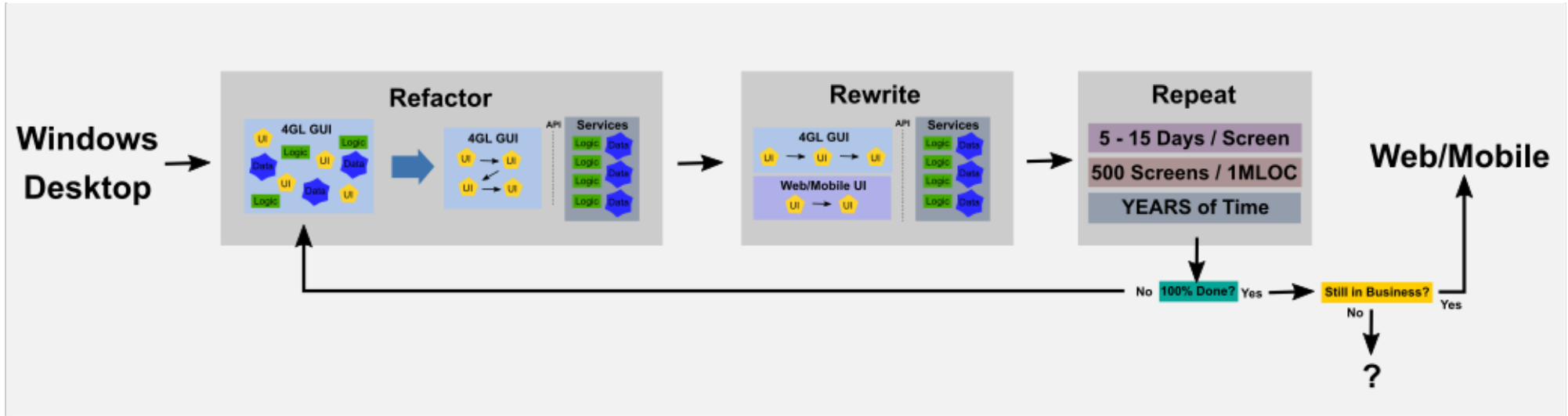

Conventional Modernization

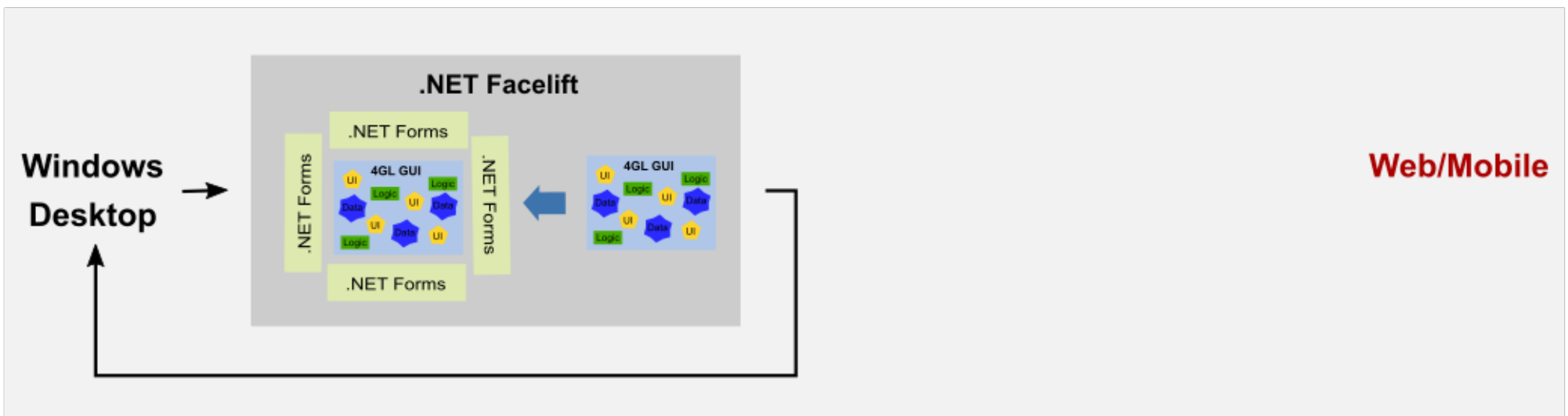
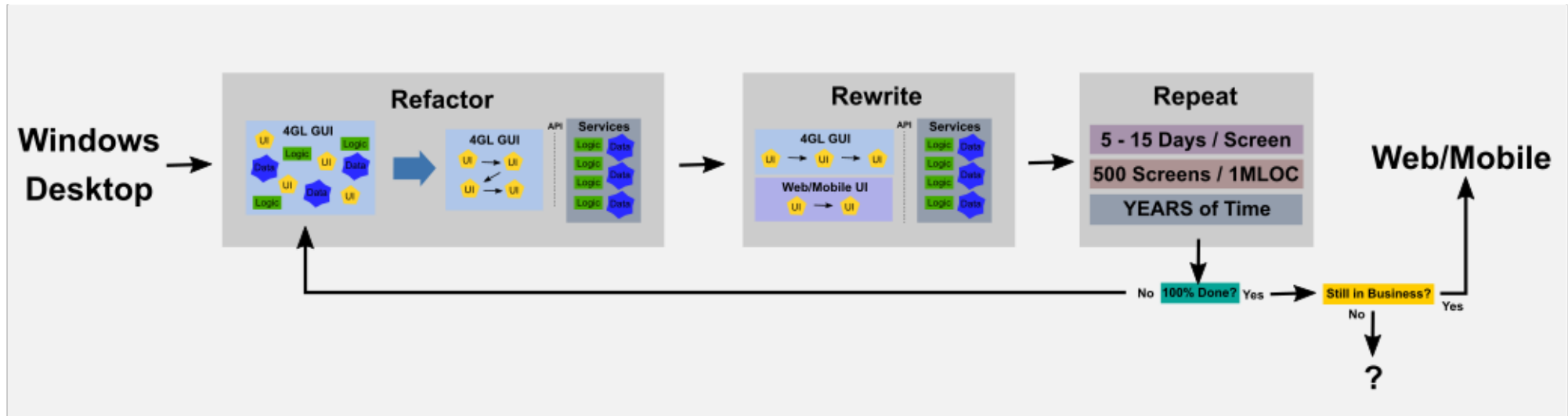

Extending 4GL GUI to the Web

- What if existing 4GL GUI could run in the web, without a rewrite?
- What if 4GL GUI features were enhanced to add new capabilities, new functionality, a modern UI approach?
 - some improvements could be implemented without code edits
 - other improvements require some new code (or changing existing code to use new features)
- Clean, evolutionary path that starts with existing GUI investment and allows developers to achieve fully modern UI without a rewrite
- Developers focus on high value screens; modernization effort is additive/incremental
- Simultaneously avoids long tail problem while future proofing existing investment
- Would require re-imagining/re-implementing core 4GL UI capabilities, from the bottom up
- This is exactly what many 4GL developers would have wanted Progress to do

FWD is this re-imagined, enhanced 4GL.

FWD



is an **open source** toolset for **modernizing** 4GL applications.

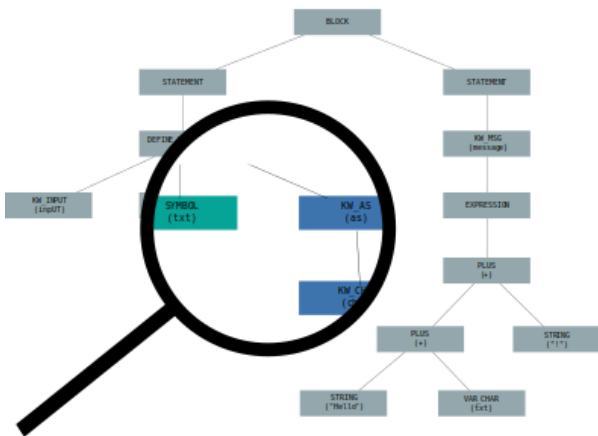

Explore

Tools for reporting, statistics and analysis, which expose the inner workings of applications.

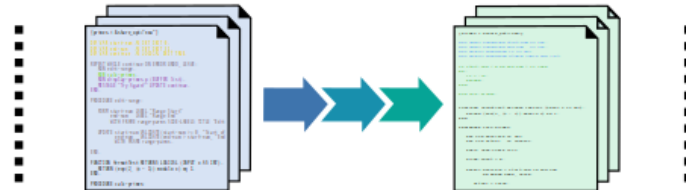

Transform

Fully automated transformation and modernization of entire applications without a manual rewrite.

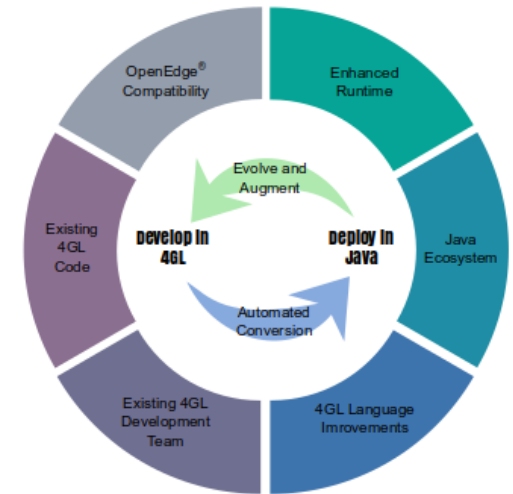

Transcend

Compatible replacement for OpenEdge® which leverages an enhanced runtime, an upgraded 4GL language and Java to modernize and evolve applications.



enhanced runtime

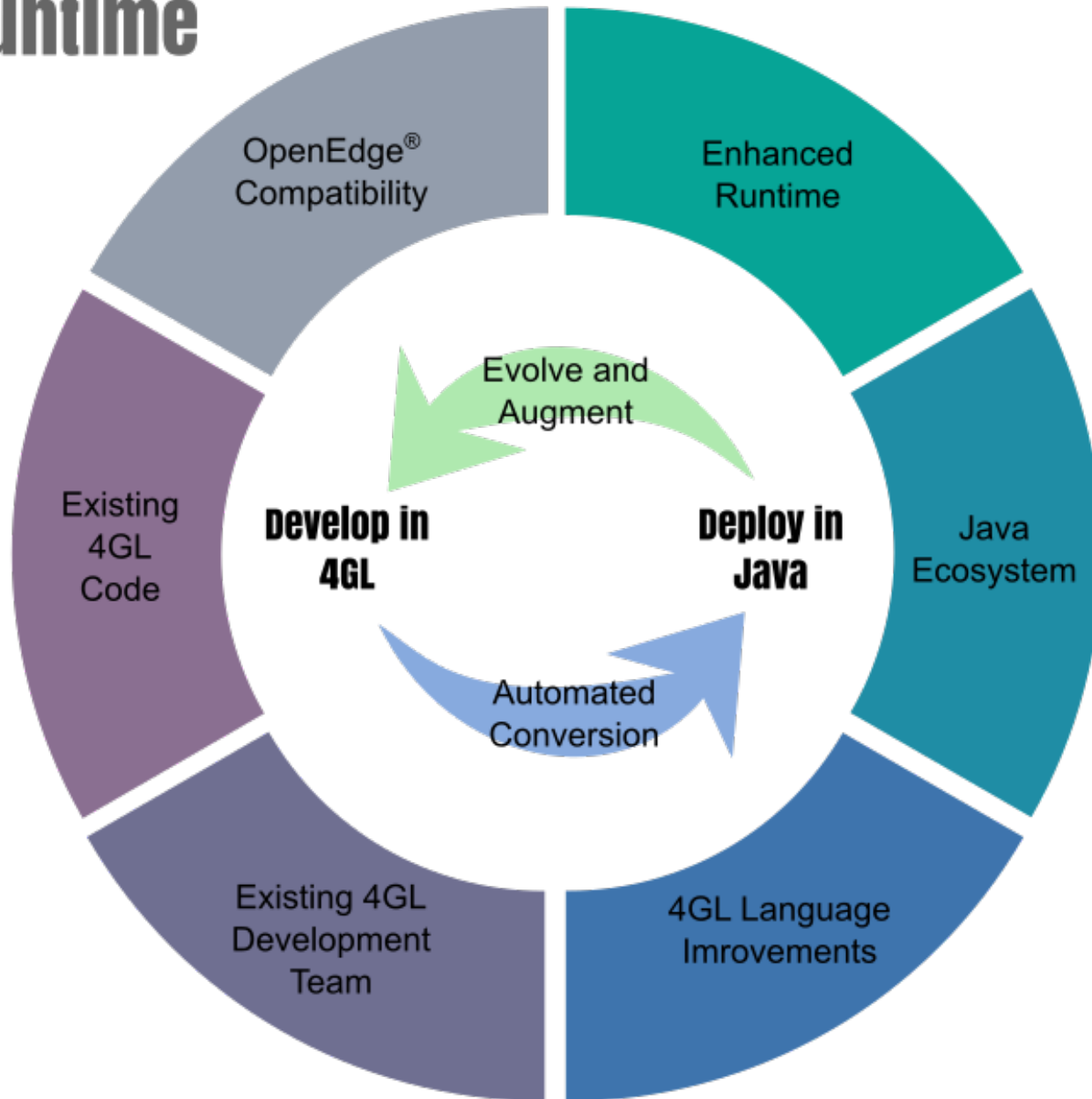



enhanced runtime

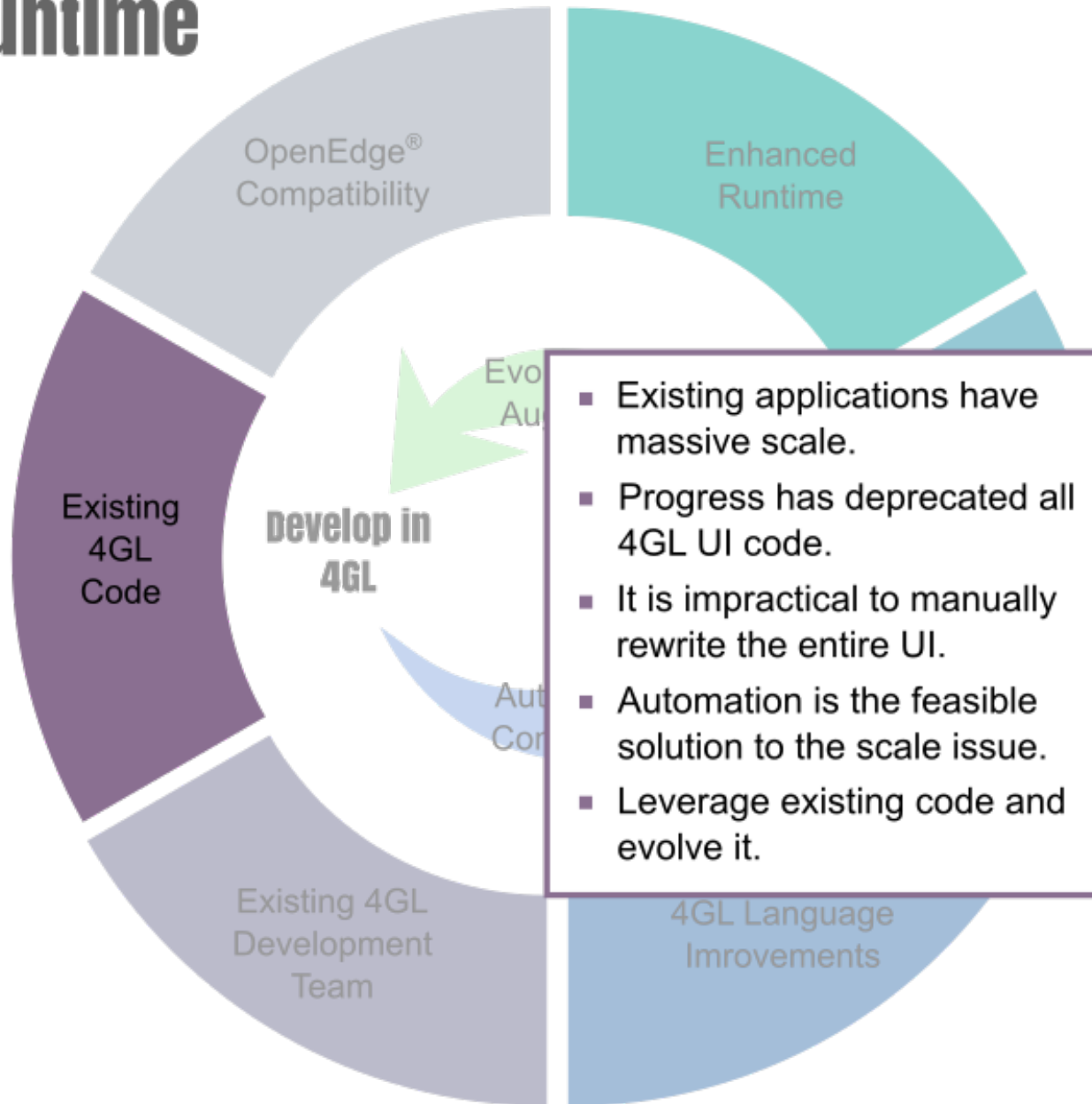

- Existing applications have massive scale.
- Progress has deprecated all 4GL UI code.
- It is impractical to manually rewrite the entire UI.
- Automation is the feasible solution to the scale issue.
- Leverage existing code and evolve it.



enhanced runtime

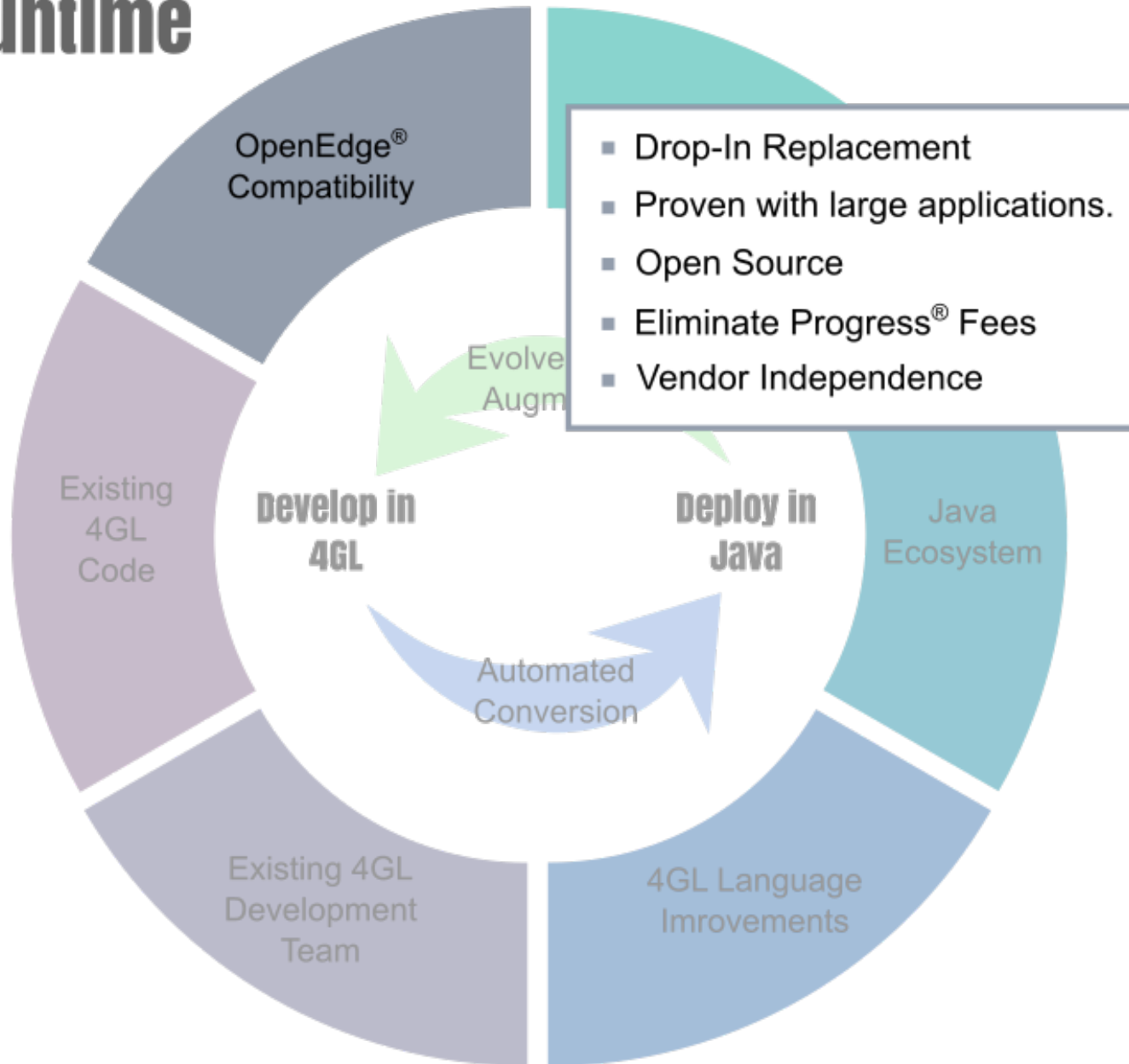



enhanced runtime

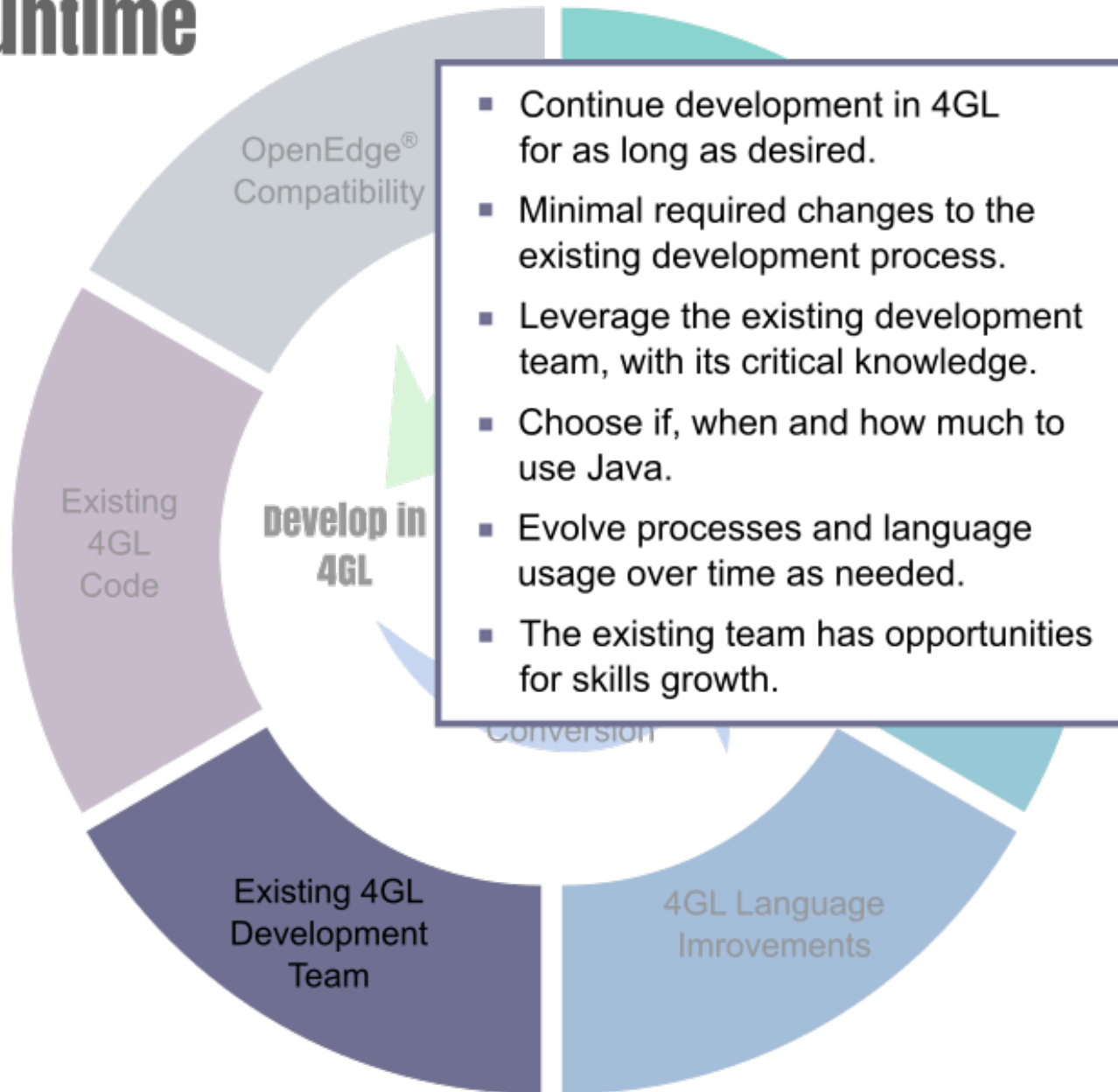



enhanced runtime



- The pool of existing Java technology is massive.
- Don't recreate the wheel.
- Easily integrate Java code into the existing application.
- Find answers on the web in seconds.
- Grow your team from over 10 million Java developers.
- Leverage an entire industry's investment.
- Books, Conferences, Education
- Development Tools, IDEs

Enhanced Runtime

Deploy in Java

Java Ecosystem

4GL Language Improvements



enhanced runtime

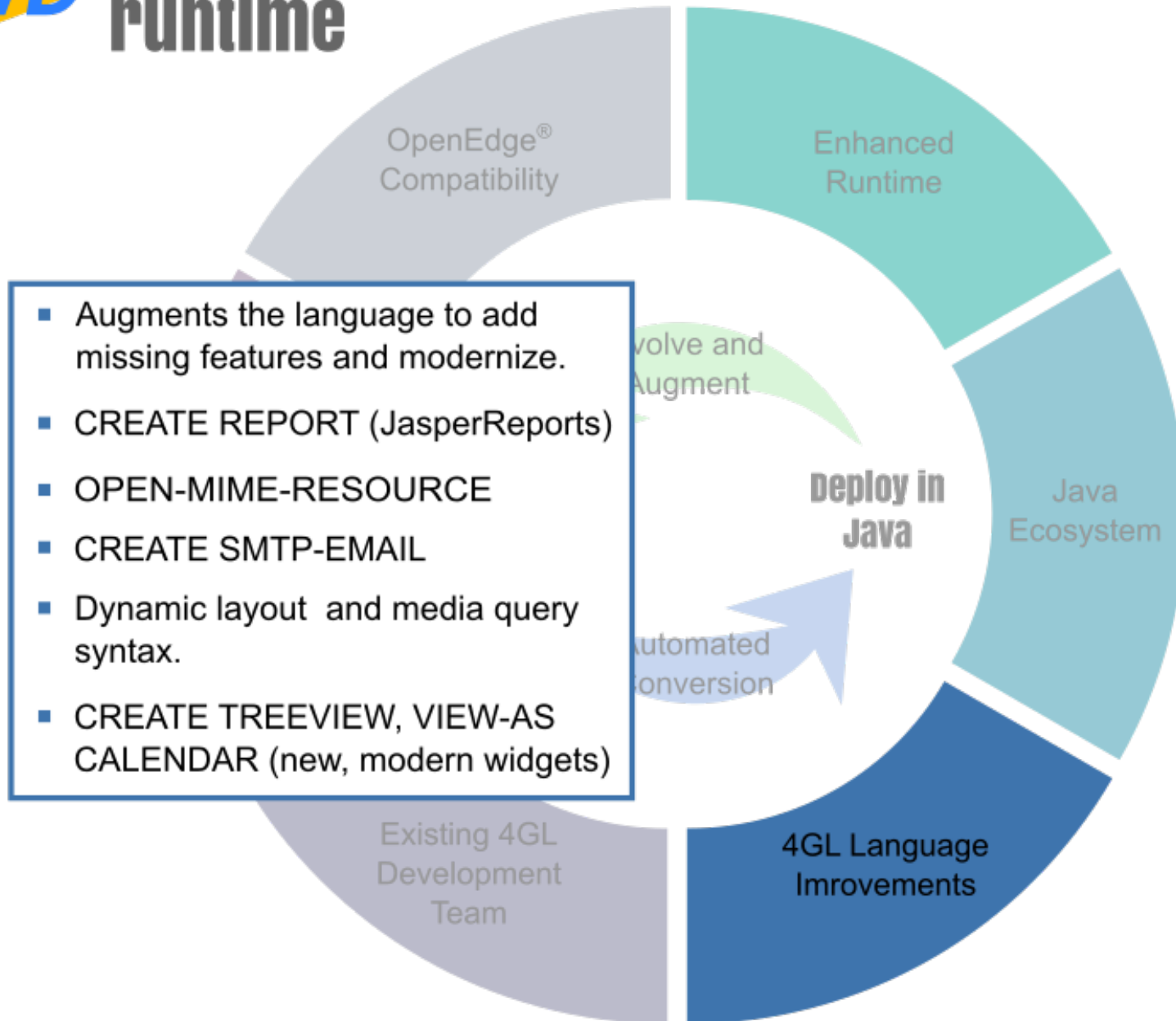



enhanced runtime

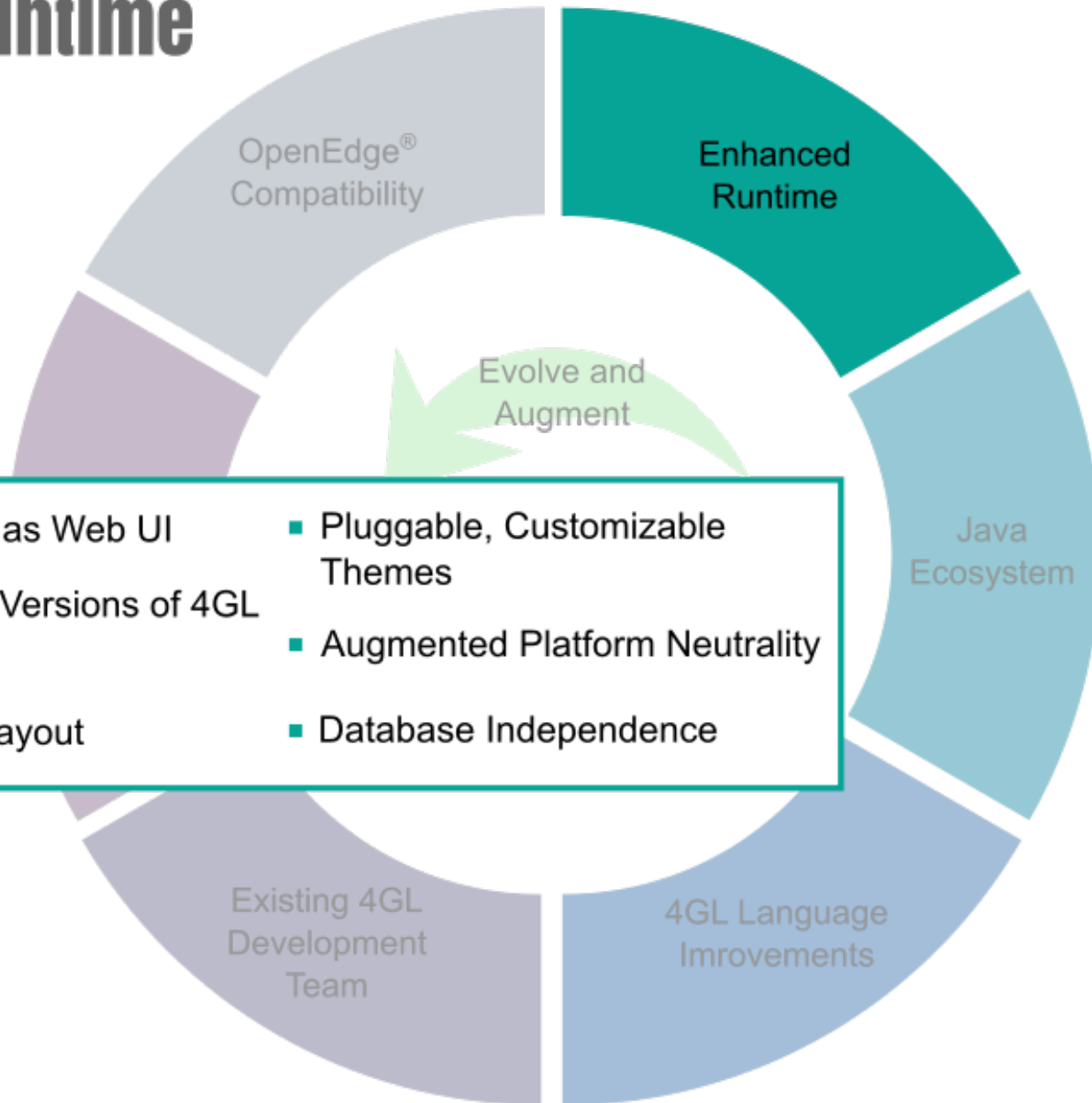

- Entire GUI as Web UI
- Enhanced Versions of 4GL Widgets
- Dynamic Layout
- Pluggable, Customizable Themes
- Augmented Platform Neutrality
- Database Independence



enhanced runtime

Key Details

- A Java engine which executes 4GL applications modernized using FWD Transform.
- Supports GUI, ChUI, batch and appserver modes.
- Leverage the rich Java ecosystem by easily integrating any Java technology into your application.
- Significant enhancements over OpenEdge®:
 - Development: FWD has an enhanced 4GL language with many new features that don't exist in OpenEdge®.
 - Runtime: Designed for database independence, platform independence and the web.
- Entire GUI applications can be deployed as a web application .
- No manual rewrite! **Eliminates years of wasted effort.**
- **The most feasible way to modernize.**
- No requirement to shift development to Java, even while using FWD for deployment.
- Existing team can continue to develop in 4GL and use FWD for deployment by re-running the fully automated conversion process.

Running 4GL GUI as Web UI

Custom Web Application

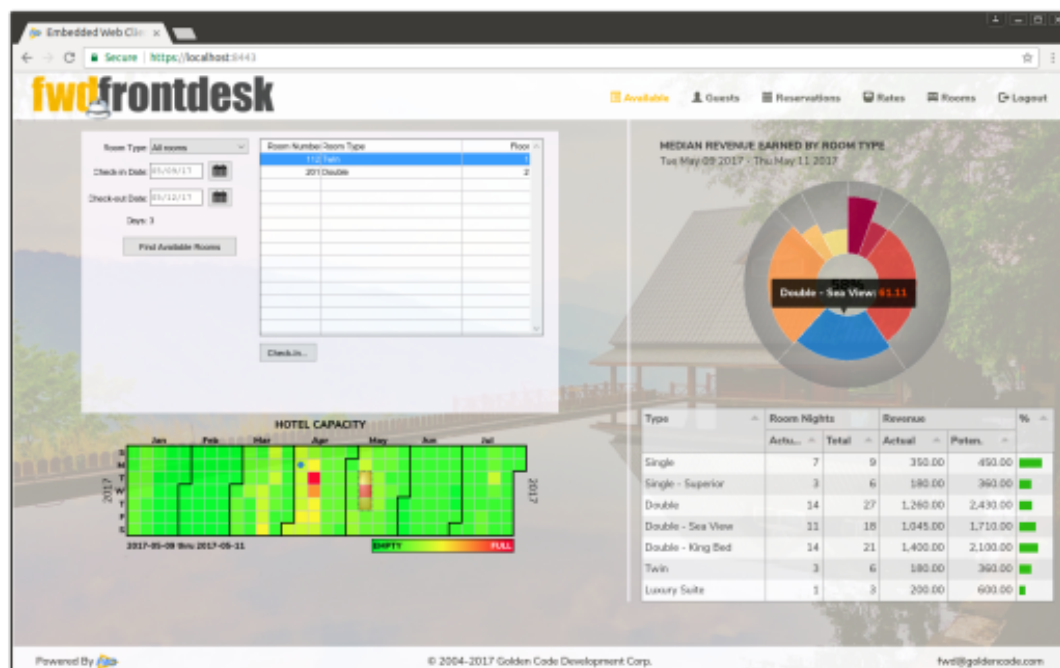

- HTML5/CSS/Javascript
- Single page application (no reloads)
- Javascript controls bound to ABL data
- FWD client as separate document in an IFrame (rectangular, visual element)
- Main (containing) document and IFrame document have different "origins"
- Cross-Document Messaging allows communication between the two

Javascript "Up-Calls"

- Create a custom web UI
- Use any browser-side Javascript tooling, controls or frameworks
- Direct calls from Javascript code to converted ABL
- Call external procedures, optionally using persistent procedures
- Internal procedures and functions can be invoked using a persistent procedure handle
- Data returned as JSON
- Easy to use data binding techniques (d3 is shown here)

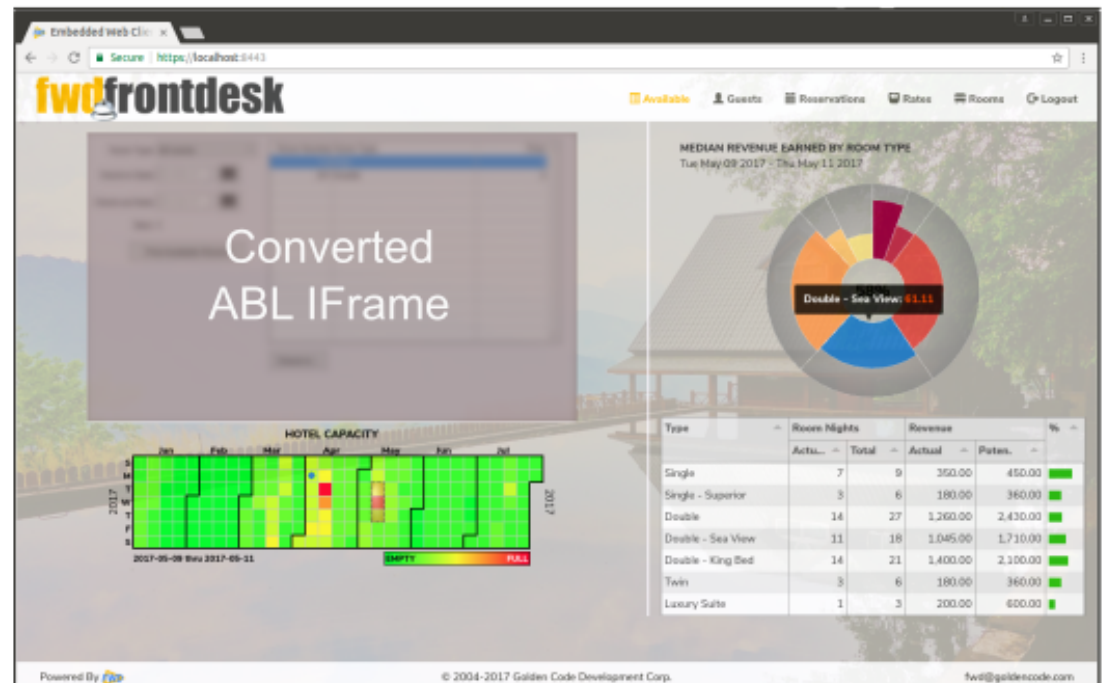

FWD Runtime Architecture

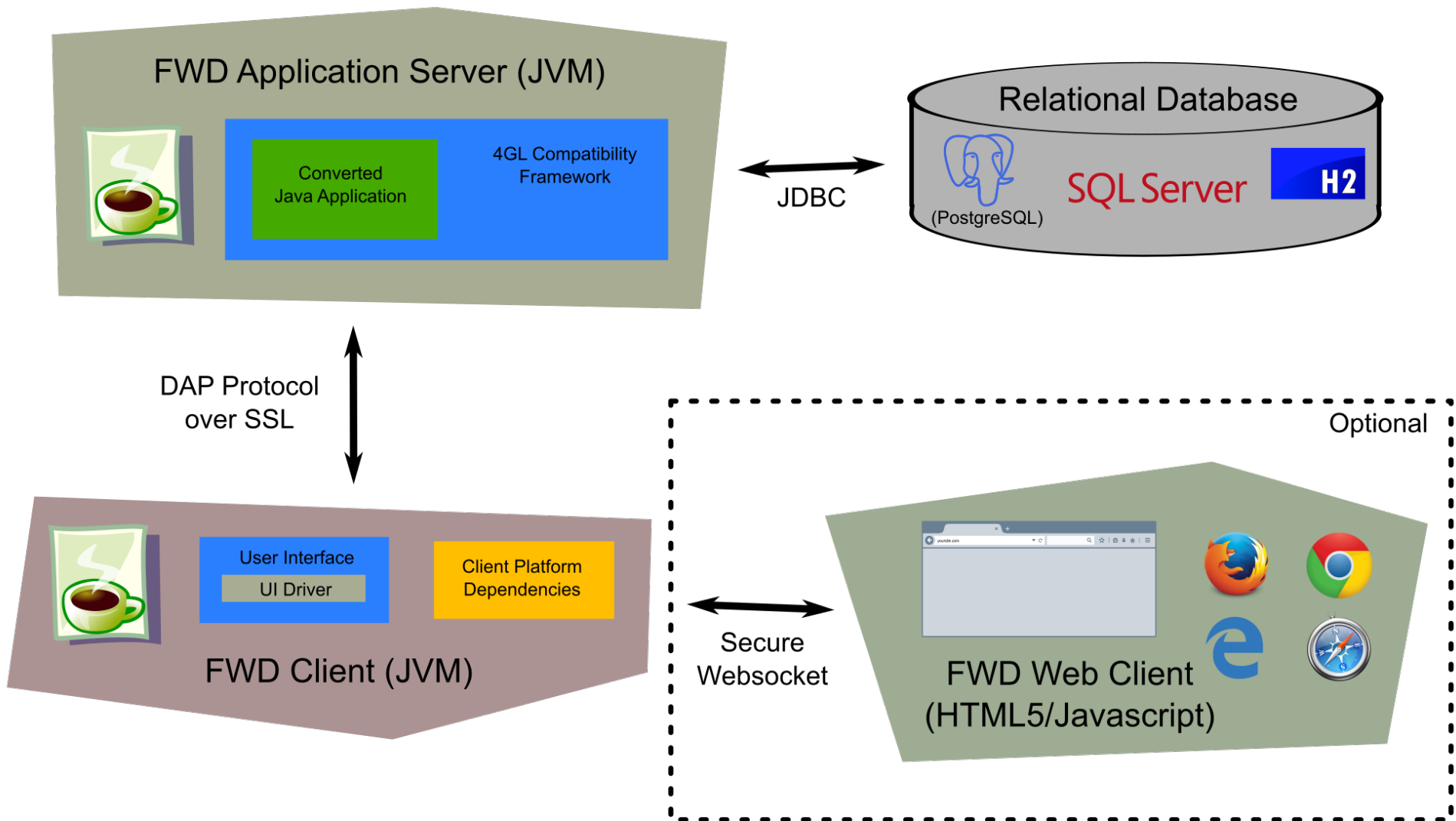

FWD Client Runtime Architecture

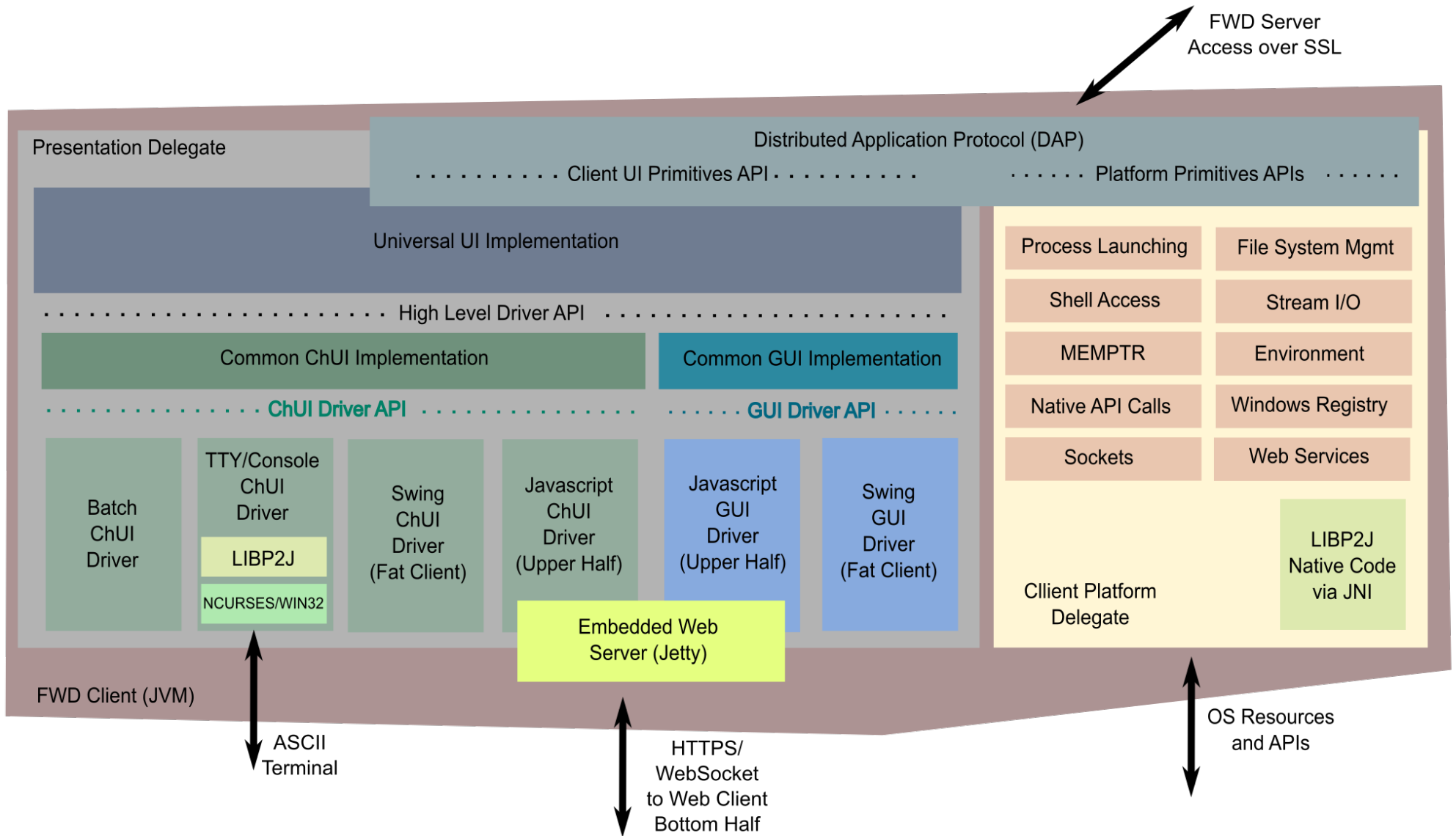

Enhanced 4GL Capabilities

Pluggable Themes

Hotel Demo FWD Application

Available Rooms **Guests** Reservations Rates Rooms

Filter by Room: Filter by Guest: Search Reset Filters

Show Past Accomodations

Room Num	Guest	Num Guest	Check-in	Check-out	Days	Room Type	Room
106	Eric Trevisano	1	12/30/16	01/12/17	13	Double	\$
209	Brooke Chapman	2	12/31/16	01/16/17	16	Double	\$
303	Paul Looney	4	01/02/17	01/17/17	15	Luxury Suite	\$
101	Cheryl Montana	1	02/28/17	03/01/17	1	Single	\$
101	Tony Montana	1	03/01/17	03/05/17	4	Single	\$
108	Marla Jones	1	04/01/17	05/01/17	30	Double	\$
112	Baxter Denison	1	04/01/17	04/16/17	15	Twin	\$
101	Bob Roberts	1	04/01/17	04/16/17	15	Single	\$
110	Jim Peterson	1	04/01/17	04/16/17	15	Double	\$
102	Leslie Michaels	1	04/01/17	04/16/17	15	Single	\$

Check-In... Check-Out... Update... Delete... Invoice pdf xls Export

Hotel Demo FWD Application

Available Rooms **Guests** Reservations Rates Rooms

Filter by Room: Filter by Guest: Search Reset Filters

Show Past Accomodations

Room Num	Guest	Num Guest	Check-in	Check-out	Days	Room Type	Room
106	Eric Trevisano	1	12/30/16	01/12/17	13	Double	\$
209	Brooke Chapman	2	12/31/16	01/16/17	16	Double	\$
303	Paul Looney	4	01/02/17	01/17/17	15	Luxury Suite	\$
101	Cheryl Montana	1	02/28/17	03/01/17	1	Single	\$
101	Tony Montana	1	03/01/17	03/05/17	4	Single	\$
108	Marla Jones	1	04/01/17	05/01/17	30	Double	\$
112	Baxter Denison	1	04/01/17	04/16/17	15	Twin	\$
101	Bob Roberts	1	04/01/17	04/16/17	15	Single	\$
110	Jim Peterson	1	04/01/17	04/16/17	15	Double	\$
102	Leslie Michaels	1	04/01/17	04/16/17	15	Single	\$

Check-In... Check-Out... Update... Delete... Invoice pdf xls Export

Hotel Demo FWD Application

Available Rooms **Guests** Reservations Rates Rooms

Filter by Room: Filter by Guest: Search Reset Filters

Show Past Accomodations

Room Num	Guest	Num Guest	Check-in	Check-out	Days	Room Type	Room
106	Eric Trevisano	1	12/30/16	01/12/17	13	Double	\$
209	Brooke Chapman	2	12/31/16	01/16/17	16	Double	\$
303	Paul Looney	4	01/02/17	01/17/17	15	Luxury Suite	\$
101	Cheryl Montana	1	02/28/17	03/01/17	1	Single	\$
101	Tony Montana	1	03/01/17	03/05/17	4	Single	\$
108	Marla Jones	1	04/01/17	05/01/17	30	Double	\$
112	Baxter Denison	1	04/01/17	04/16/17	15	Twin	\$
101	Bob Roberts	1	04/01/17	04/16/17	15	Single	\$
110	Jim Peterson	1	04/01/17	04/16/17	15	Double	\$
102	Leslie Michaels	1	04/01/17	04/16/17	15	Single	\$

Check-In... Check-Out... Update... Delete... Invoice pdf xls Export

Hotel Demo FWD Application

Available Rooms **Guests** Reservations Rates Rooms

Filter by Room: Filter by Guest: Search Reset Filters

Show Past Accomodations

Room Num	Guest	Num Guest	Check-in	Check-out	Days	Room Type	Room
106	Eric Trevisano	1	12/30/16	01/12/17	13	Double	\$ 1.
209	Brooke Chapman	2	12/31/16	01/16/17	16	Double	\$ 1.
303	Paul Looney	4	01/02/17	01/17/17	15	Luxury Suite	\$ 3.
101	Cheryl Montana	1	02/28/17	03/01/17	1	Single	\$
101	Tony Montana	1	03/01/17	03/05/17	4	Single	\$
108	Marla Jones	1	04/01/17	05/01/17	30	Double	\$ 2.
112	Baxter Denison	1	04/01/17	04/16/17	15	Twin	\$
101	Bob Roberts	1	04/01/17	04/16/17	15	Single	\$
110	Jim Peterson	1	04/01/17	04/16/17	15	Double	\$ 1.
102	Leslie Michaels	1	04/01/17	04/16/17	15	Single	\$

Check-In... Check-Out... Update... Delete... Invoice pdf xls Export

Pluggable Themes

- Pixel level control over widget drawing.
- Control colors and fonts.
- Each widget type has its own drawing routines that can be overridden.
- Subclass the built-in themes and just override the parts you need.
- Build your own from scratch.
- Each FWD client session can use a different theme.
- The theme is chosen when the client is started.

Enhanced Browse - Filtering

Room Type	Start Date	End Date	Rate
<u>Double</u> ✖	_____ ✖	_____ ✖	_____ ✖
Double	09/01/18	05/31/19	\$ 90.00
Double	06/01/19	08/31/19	\$ 117.00
Double	09/01/19	01/01/30	\$ 90.00
Double - Sea View	09/01/18	05/31/19	\$ 95.00
Double - Sea View	06/01/19	08/31/19	\$ 124.00
Double - Sea View	09/01/19	01/01/30	\$ 95.00
Double - King Bed	09/01/18	05/31/19	\$ 100.00
Double - King Bed	06/01/19	08/31/19	\$ 130.00
Double - King Bed	09/01/19	01/01/30	\$ 100.00

Enhanced Browse - Sorting

Hotel Demo FWD Application

Logout Exit

Available Rooms Guests Reservations Rates Rooms

Filter by Room: Filter by Guest: Search Reset Filters

Show Past Accomodations

Room Num	Guest	Num Guests	Check-in	Check-out	Days	Room Type	Room Price
106	Eric Trevisano			12/17	13	Double	\$ 1,170
209	Brooke Chapman			16/17	16	Double	\$ 1,440
303	Paul Looney			17/17	15	Luxury Suite	\$ 3,000
101	Cheryl Montana	1	02/28/17	03/01/17	1	Single	\$ 50
101	Tony Montana	1	03/01/17	03/05/17	4	Single	\$ 200
108	Maria Jones	1	04/01/17	05/01/17	30	Double	\$ 2,700
112	Baxter Denison	1	04/01/17	04/16/17	15	Twin	\$ 900
101	Bob Roberts	1	04/01/17	04/16/17	15	Single	\$ 750
110	Jim Peterson	1	04/01/17	04/16/17	15	Double	\$ 1,350
102	Leslie Michaels	1	04/01/17	04/16/17	15	Single	\$ 750
102	Joseph Nighton	1	03/01/17	03/05/17	4	Single	\$ 200
103	Betty Smith	1	04/09/17	04/16/17	7	Single	\$ 350
207	Richard Bolinger	1	04/11/17	04/20/17	9	Double - King Bed	\$ 900
202	Marilyn Tethburg	1	04/10/17	04/13/17	3	Double - Sea View	\$ 285
104	Andrew Jones	1	04/11/17	04/12/17	1	Single - Superior	\$ 60
105	Melody Sinjun	1	04/11/17	04/12/17	1	Single - Superior	\$ 60
303	Harold Delphi	1	04/01/17	04/14/17	13	Luxury Suite	\$ 2,600
107	Jerry Yellin	1	04/11/17	04/12/17	1	Double - Sea View	\$ 95
201	Marge Himple	1	04/11/17	04/12/17	1	Double	\$ 90
306	Rafael Jiminez	1	04/11/17	04/12/17	1	Double - King Bed	\$ 100
203	Sherry Larrow	1	04/11/17	04/13/17	2	Double	\$ 180
205	Mitch Telfoy	1	04/11/17	04/15/17	4	Double	\$ 360
302	Carl Mayweather	1	04/11/17	04/12/17	1	Double	\$ 90
202	Martha Romaine	1	03/02/17	03/09/17	7	Double - Sea View	\$ 665
305	Nathan Petri	1	03/02/17	03/09/17	7	Double - King Bed	\$ 700

Apply Reset

Check-In... Check-Out... Update... Delete... Invoice pdf xls Export

Enhanced Browse - Sorting

Room Num ▲3	Guest	Num Guests	Check-in ▼1	Check-out	Days	Room Type ▲2	Room Price ▲
106	Eric Trevisano			12/17	13	Double	\$ 1,170
209	Brooke Chapman			16/17	16	Double	\$ 1,440
303	Paul Looney			17/17	15	Luxury Suite	\$ 3,000
101	Sheryl Matthews	1	02/01/17	02/01/17	1	Single	\$ 500

Sorting has been changed

Apply Reset

Enhanced Browse - Sorting

Hotel Demo FWD Application Logout Exit

Available Rooms **Guests** Reservations Rates Rooms

Filter by Room: Filter by Guest:

Show Past Accomodations

Room Num	Guest	Num Guests	Check-in	Check-out	Days	Room Type	Room Price
106	Mary Jane	1	11/15/17	11/20/17	5	Double	\$ 450
201	Sara Flower	1	11/15/17	11/17/17	2	Double	\$ 180
203	Sue Sarong	1	11/15/17	11/20/17	5	Double	\$ 450
209	Bill Williams	1	11/15/17	11/16/17	1	Double	\$ 90
301	Sally Caruthers	1	11/15/17	11/17/17	2	Double	\$ 180
302	Mandy Moore	1	11/15/17	11/16/17	1	Double	\$ 90
308	Billy Zone	1	11/15/17	11/16/17	1	Double - King Bed	\$ 100
210	George Bailey	1	11/15/17	11/17/17	2	Double - Sea View	\$ 190
102	Marcus Blix	1	11/15/17	11/16/17	1	Single	\$ 50
103	Max Tiger	1	11/15/17	11/16/17	1	Single	\$ 50
104	Drew Pine	1	11/15/17	11/17/17	2	Single - Superior	\$ 120
111	Despacito Jones	1	11/15/17	11/16/17	1	Twin	\$ 60
207	Taylor Swift	1	11/13/17	11/30/17	17	Double - King Bed	\$ 1,700
208	Jonas Polk	1	11/13/17	11/20/17	7	Double - King Bed	\$ 700
305	Leif Erikson	1	11/13/17	11/30/17	17	Double - King Bed	\$ 1,700
306	Mary Smith	1	11/13/17	11/30/17	17	Double - King Bed	\$ 1,700
307	Keith Richards	1	11/13/17	11/20/17	7	Double - King Bed	\$ 700
109	Jane Robinson	1	11/13/17	11/30/17	17	Double - Sea View	\$ 1,615
202	Maria Lopez	1	11/13/17	11/30/17	17	Double - Sea View	\$ 1,615
204	Tatum Channing	1	11/13/17	11/30/17	17	Double - Sea View	\$ 1,615
206	Mick Jagger	1	11/13/17	11/20/17	7	Double - Sea View	\$ 665
105	John Jackson	1	11/13/17	11/30/17	17	Single - Superior	\$ 1,020
107	Erik Johnson	1	11/09/17	11/25/17	16	Double - Sea View	\$ 1,520
303	Jane Doe	1	11/09/17	11/25/17	16	Luxury Suite	\$ 3,200
108	Random Dude	1	10/29/17	11/15/17	17	Double	\$ 1,530

pdf xls

Enhanced Browse - Export

Hotel Demo FWD Application

Logout Exit

Available Rooms Guests Reservations Rates Rooms

Filter by Room: Filter by Guest: Search Reset Filters

Show Past Accommodations

Room Num	Guest	Num Guests	Check-in	Check-out	Days	Room Type	Room Price
106	Mary Jane	1	11/15/17	11/20/17	5	Double	\$ 450
201	Sara Flower						\$ 180
203	Sue Sarong						\$ 450
209	Bill Williams						\$ 90
210	George Bailey	1	11/15/17	11/17/17			\$ 190
301	Sally Caruthers	1	11/15/17	11/17/17			\$ 180
302	Mandy Moore	1	11/15/17	11/16/17	1	Double	\$ 90
308	Billy Zone	1	11/15/17	11/16/17	1	Double - King Bed	\$ 100
109	Jane Robinson	17	11/13/17	11/30/17	17	Double - Sea View	\$ 1,615
202	Maria Lopez	17	11/13/17	11/30/17	17	Double - Sea View	\$ 1,615
204	Tatum Channing	17	11/13/17	11/30/17	17	Double - Sea View	\$ 1,615
206	Mick Jagger	7	11/13/17	11/20/17	7	Double - Sea View	\$ 665
207	Taylor Swift	17	11/13/17	11/30/17	17	Double - King Bed	\$ 1,700
208	Jonas Polk	7	11/13/17	11/20/17	7	Double - King Bed	\$ 700
305	Leif Erikson	17	11/13/17	11/30/17	17	Double - King Bed	\$ 1,700
306	Mary Smith	17	11/13/17	11/30/17	17	Double - King Bed	\$ 1,700
307	Keith Richards	7	11/13/17	11/20/17	7	Double - King Bed	\$ 700
107	Erik Johnson	16	11/09/17	11/25/17	16	Double - Sea View	\$ 1,520
108	Random Dude	17	10/29/17	11/15/17	17	Double	\$ 1,530
109	Silly Putty	12	10/29/17	11/10/17	12	Double - Sea View	\$ 1,140
201	Water Bonner	2	10/28/17	07/30/17	2	Double	\$ 234
206	Horatio Ponz	1	10/7/19/17	07/20/17	1	Double - Sea View	\$ 124
209	Lester Burwell	1	10/7/19/17	07/20/17	1	Double	\$ 117
202	Montique Parker-Hampton	1	10/7/18/17	07/19/17	1	Double - Sea View	\$ 124

Export to PDF
Export to CSV
Export to XLS
Export to XLSX

Check-In... Check-Out... Update... Delete... Invoice pdf xls Export

Enhanced Browse – Export PDF

Browse Report

Room Num	Guest	Num Guests	Check-in	Check-out	Days	Room Type	Room Price
106	Mary Jane	1	11/15/17	11/20/17	5	Double	\$ 450
201	Sara Flower	1	11/15/17	11/17/17	2	Double	\$ 180
203	Sue Sarong	1	11/15/17	11/20/17	5	Double	\$ 450
209	Bill Williams	1	11/15/17	11/16/17	1	Double	\$ 90
210	George Bailey	1	11/15/17	11/17/17	2	Double - Sea View	\$ 190
301	Sally Caruthers	1	11/15/17	11/17/17	2	Double	\$ 180
302	Mandy Moore	1	11/15/17	11/16/17	1	Double	\$ 90
308	Billy Zone	1	11/15/17	11/16/17	1	Double - King Bed	\$ 100
109	Jane Robinson	1	11/13/17	11/30/17	17	Double - Sea View	\$ 1,615
202	Maria Lopez	1	11/13/17	11/30/17	17	Double - Sea View	\$ 1,615
204	Tatum Channing	1	11/13/17	11/30/17	17	Double - Sea View	\$ 1,615
206	Mick Jagger	1	11/13/17	11/20/17	7	Double - Sea View	\$ 665
207	Taylor Swift	1	11/13/17	11/30/17	17	Double - King Bed	\$ 1,700
208	Jonas Polk	1	11/13/17	11/20/17	7	Double - King Bed	\$ 700
305	Leif Erikson	1	11/13/17	11/30/17	17	Double - King Bed	\$ 1,700
306	Mary Smith	1	11/13/17	11/30/17	17	Double - King Bed	\$ 1,700
307	Keith Richards	1	11/13/17	11/20/17	7	Double - King Bed	\$ 700
107	Erik Johnson	1	11/09/17	11/25/17	16	Double - Sea View	\$ 1,520
108	Random Dude	1	10/29/17	11/15/17	17	Double	\$ 1,530
109	Silly Putty	1	10/29/17	11/10/17	12	Double - Sea View	\$ 1,140
201	Walter Bonner	1	07/28/17	07/30/17	2	Double	\$ 234
206	Horatio Ponz	1	07/19/17	07/20/17	1	Double - Sea View	\$ 124
209	Lester Burwell	1	07/19/17	07/20/17	1	Double	\$ 117
202	Montigue Parker-Hampton	1	07/18/17	07/19/17	1	Double - Sea View	\$ 124
203	Patricia Fowler	1	07/18/17	07/19/17	1	Double	\$ 117
204	James Bowles	1	07/18/17	07/19/17	1	Double - Sea View	\$ 124
306	Sally Pancheto	1	07/18/17	07/19/17	1	Double - King Bed	\$ 130
108	Barton Wenz	1	07/17/17	07/22/17	5	Double	\$ 585
110	Gerald Marchone	1	07/17/17	07/26/17	9	Double	\$ 1,053
205	Cranston Biggles	1	07/17/17	08/01/17	15	Double	\$ 1,755
206	James Booth	1	07/16/17	07/19/17	3	Double - Sea View	\$ 372
304	Sheila Grant	1	07/16/17	07/27/17	11	Double - King Bed	\$ 1,430
107	Horst Unverstolben-Ytzvig	1	07/13/17	07/22/17	9	Double - Sea View	\$ 1,116
301	Wolfram Siebert	1	07/13/17	07/22/17	9	Double	\$ 1,053
106	Chelsea Brighton	1	07/05/17	07/06/17	1	Double	\$ 117
307	Donald Mitchum	1	07/05/17	07/06/17	1	Double - King Bed	\$ 130
201	Alejandro Rodriguez	1	07/02/17	07/20/17	18	Double	\$ 2,106

Enhanced Browse – Hyperlinking

```
DEFINE BROWSE staysBrowse  
  
  QUERY staysBrowse NO-LOCK DISPLAY  
  
    stay.room-num HYPERLINK "xprint-invoice"  
  
    COLUMN-LABEL "Room Num" ...
```

```
PROCEDURE xprint-invoice:
```

```
  def input param xroom-num as char.
```

```
  ...
```

```
END.
```

```
subscribe to "xprint-invoice" anywhere
```

```
run-procedure "xprint-invoice".
```

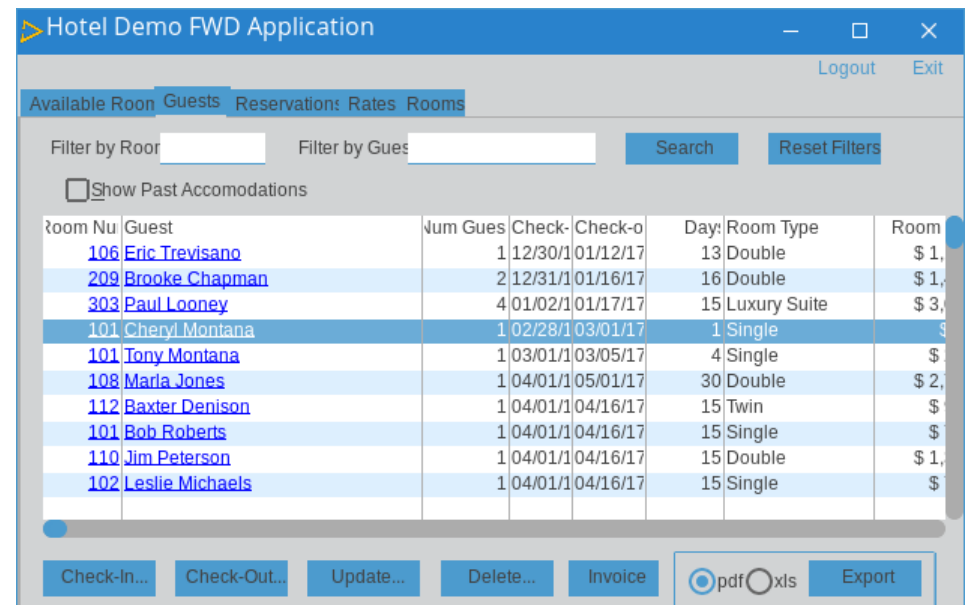

The screenshot shows a web application window titled "Hotel Demo FWD Application". The interface includes a navigation menu with "Available Room", "Guests", "Reservations", "Rates", and "Rooms". Below the menu are filter fields for "Filter by Room" and "Filter by Guest", along with "Search" and "Reset Filters" buttons. A checkbox labeled "Show Past Accommodations" is also present. The main content is a table with the following columns: Room Nu, Guest, Num Gues, Check-in, Check-out, Day, Room Type, and Room Price. The "Guest" column contains blue hyperlinks for each reservation. At the bottom of the interface, there are buttons for "Check-In...", "Check-Out...", "Update...", "Delete...", "Invoice", and "Export" (with radio buttons for "pdf" and "xls").

Room Nu	Guest	Num Gues	Check-in	Check-out	Day	Room Type	Room Price
106	Eric Trevisano	1	12/30/17	01/12/17	13	Double	\$ 1,...
209	Brooke Chapman	2	12/31/17	01/16/17	16	Double	\$ 1,...
303	Paul Looney	4	01/02/17	01/17/17	15	Luxury Suite	\$ 3,...
101	Cheryl Montana	1	02/28/17	03/01/17	1	Single	\$
101	Tony Montana	1	03/01/17	03/05/17	4	Single	\$
108	Marla Jones	1	04/01/17	05/01/17	30	Double	\$ 2,...
112	Baxter Denison	1	04/01/17	04/16/17	15	Twin	\$
101	Bob Roberts	1	04/01/17	04/16/17	15	Single	\$
110	Jim Peterson	1	04/01/17	04/16/17	15	Double	\$ 1,...
102	Leslie Michaels	1	04/01/17	04/16/17	15	Single	\$

Better Widgets

- Improve existing widgets, browse is already complete.
- Direct use as 4GL syntax extensions (e.g. VIEW-AS CALENDAR or CREATE TREE-VIEW)
- New widgets are first class 4GL widgets
- Enhanced versions of widgets optionally enabled at runtime (by cfg) or by use of new 4GL keywords
- Not yet available (this work is in process now), the images are for illustration only

Add New Widgets

The screenshot displays a software interface with several widgets:

- Toolbar:** A horizontal toolbar with icons for Copy, Bold (B), Italic (I), Dropdowns, TooltipDialog, ColorPalette, and Combox: Menu.
- Tree:** A hierarchical tree structure with nodes like "Item 2.1", "test", and "Item 2.2".
- Tabs:** A tabbed interface with three tabs labeled "Tab 1", "Tab 2", and "Tab 3".
- Calendar:** A calendar widget showing the month of April with dates from 1 to 30.
- Data Visualization:** A complex visualization area containing a network graph, a "Deep Brain Stimulation" plot, and a list of references.

Data Visualization (SVG + data/event binding)

Deep Brain Stimulation

Year	Month	Day	Event
2016	April	1	Experimental brain research...
2016	April	2	Journal of neurology...
2016	April	3	Journal of neurology...
2016	April	4	Brain: a journal of neurology...
2016	April	5	Experimental neurology...
2016	April	6	Conference proceedings...
2016	April	7	Acta neurochirurgica...
2016	April	8	The Journal of neuroscience...
2016	April	9	Journal of neurology...
2016	April	10	Neuroscience (journal of)...
2016	April	11	Acta neurochirurgica...
2016	April	12	Acta neurochirurgica...
2016	April	13	Acta neurochirurgica...
2016	April	14	Acta neurochirurgica...
2016	April	15	Acta neurochirurgica...
2016	April	16	Acta neurochirurgica...
2016	April	17	Acta neurochirurgica...
2016	April	18	Acta neurochirurgica...
2016	April	19	Acta neurochirurgica...
2016	April	20	Acta neurochirurgica...
2016	April	21	Acta neurochirurgica...
2016	April	22	Acta neurochirurgica...
2016	April	23	Acta neurochirurgica...
2016	April	24	Acta neurochirurgica...
2016	April	25	Acta neurochirurgica...
2016	April	26	Acta neurochirurgica...
2016	April	27	Acta neurochirurgica...
2016	April	28	Acta neurochirurgica...
2016	April	29	Acta neurochirurgica...
2016	April	30	Acta neurochirurgica...

Dynamic Layout Phase 1

Hotel Demo FWD Application

Logout Exit

Available Rooms Guests Reservations Rates Rooms

Show Past Rates

Room Type	Start Date	End Date	Rate
Double - King Bed	06/01/18	08/31/18	\$ 130.00
Double - King Bed	09/01/18	05/31/19	\$ 100.00
Double - King Bed	06/01/19	08/31/19	\$ 130.00
Double - King Bed	09/01/19	01/01/30	\$ 100.00
Twin	06/01/16	08/31/16	\$ 78.00
Twin	09/01/16	05/31/17	\$ 60.00
Twin	06/01/17	08/31/17	\$ 78.00
Twin	09/01/17	05/31/18	\$ 60.00
Twin	06/01/18	08/31/18	\$ 78.00
Twin	09/01/18	05/31/19	\$ 60.00
Twin	06/01/19	08/31/19	\$ 78.00
Twin	09/01/19	01/01/30	\$ 60.00
Luxury Suite	06/01/16	08/31/16	\$ 260.00
Luxury Suite	09/01/16	05/31/17	\$ 200.00
Luxury Suite	06/01/17	08/31/17	\$ 260.00



Add... Delete... Update...

Hotel Demo FWD Application

Logout Exit

Available Rooms Guests Reservations Rates Rooms

Show Past Rates

Room Type	Start Date	End Date	Rate
Double - King Bed	06/01/18	08/31/18	\$ 130.00
Double - King Bed	09/01/18	05/31/19	\$ 100.00
Double - King Bed	06/01/19	08/31/19	\$ 130.00
Double - King Bed	09/01/19	01/01/30	\$ 100.00
Twin	06/01/16	08/31/16	\$ 78.00
Twin	09/01/16	05/31/17	\$ 60.00
Twin	06/01/17	08/31/17	\$ 78.00
Twin	09/01/17	05/31/18	\$ 60.00
Twin	06/01/18	08/31/18	\$ 78.00
Twin	09/01/18	05/31/19	\$ 60.00
Twin	06/01/19	08/31/19	\$ 78.00
Twin	09/01/19	01/01/30	\$ 60.00
Luxury Suite	06/01/16	08/31/16	\$ 260.00
Luxury Suite	09/01/16	05/31/17	\$ 200.00



Add... Delete... Update...

Dynamic Layout Phase 2

- ◆ Encode a layout strategy at the window and frame level in 4GL code (e.g. LAYOUT EQUAL-COLUMNS or LAYOUT CARD)
- ◆ Dynamic layout and resizing of a window (and its contained frames) in response to device media queries (the screen size/resolution determines how the layout renders)
- ◆ In this example, a multi-column layout on a wider screen will naturally render in a single column on a phone screen - same 4GL code, different runtime result
- ◆ Not yet available (this work is in process now)

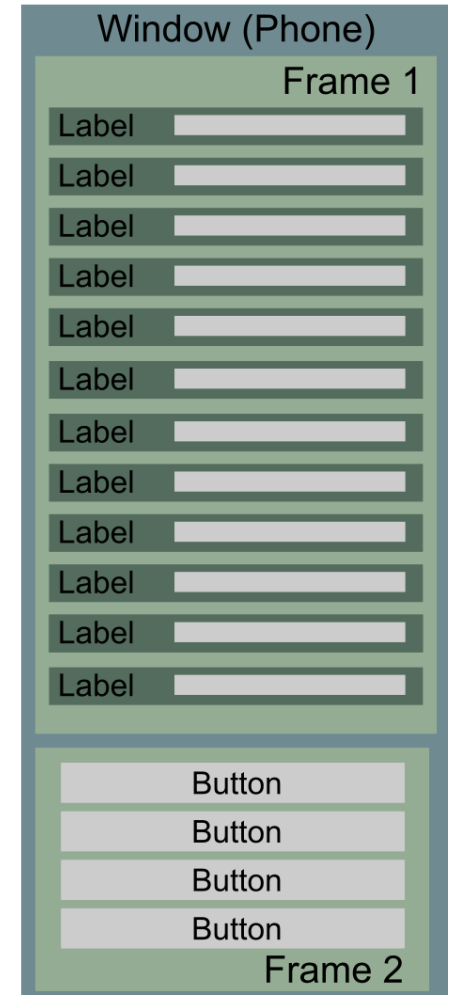
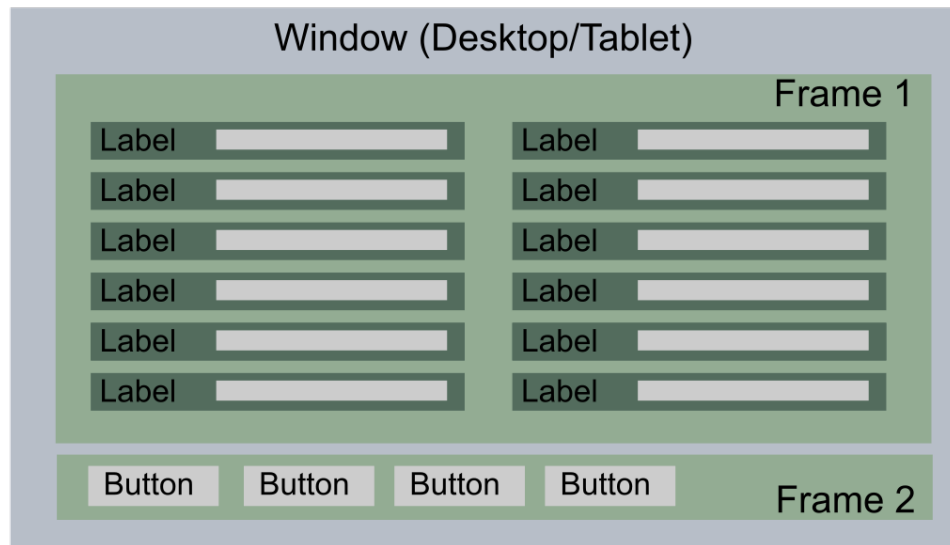

Report Engine

```
OPEN QUERY qRpt FOR EACH person.
```

```
DEF VAR rptPdf AS HANDLE.
```

```
DEF VAR rptName AS CHAR FORMAT "X(256)".
```

```
rptName = GUID(GENERATE-UUID) + ".pdf".
```

```
CREATE REPORT rptPdf.
```

```
rptPdf:report-data-source = QUERY qRpt:handle.
```

```
rptPdf:report-design = "jrxml/guests_report_pdf.jrxml".
```

```
rptPdf:set-report-param("ReportTitle", "Guests Accomodation Report").
```

```
rptPdf:export-report-pdf(rptName).
```

```
OPEN-MIME-RESOURCE "application/pdf" STRING("file:/// " + rptName) false.
```

Report Engine

Guests Accomodation Report

Room #	Guest Name	Gsts	Check-In	Chck-Out	Days	Type	Price
202	Charles Wood	2	12/03/16	12/17/17	379	Double - Sea View	\$ 1425
202	Naomi Wood	2	12/03/16	12/17/17	379	Double - Sea View	\$ 1425
101	Sandra Higdon	1	12/23/16	12/28/17	370	Single	\$ 250
106	Eric Trevisano	1	12/30/16	01/12/17	13	Double	\$ 1170
209	Brooke Chapman	2	12/31/16	01/16/17	16	Double	\$ 1440
209	Hollie Chapman	2	12/31/16	01/16/17	16	Double	\$ 1440
303	Paul Looney	4	01/02/17	01/17/17	15	Luxury Suite	\$ 3000
303	Bernice Howard	4	01/02/17	01/17/17	15	Luxury Suite	\$ 3000
303	George Johnson	4	01/02/17	01/17/17	15	Luxury Suite	\$ 3000
303	Alice Threet	4	01/02/17	01/17/17	15	Luxury Suite	\$ 3000
101	Cheryl Montana	1	02/28/17	03/01/17	1	Single	\$ 50

- JasperReports engine.
- Integrated with the FWD application server.
- New 4GL language syntax to access it.
- MUCH easier than integrating with JasperReports from OpenEdge.
- Output in any format supported (PDF, XLS...).

Status

Status

- FWD v3.2 is available now, includes most of what was shown.
- FWD v3.3
 - Expected in November 2018.
 - Will include the recent changes for:
 - Enhanced Browse
 - Material Theme
 - Dynamic Layout Phase 1
- FWD v3.4
 - Expected February 2018
 - New widgets (treeview, browser pages embedded in 4GL windows).
 - OO 4GL

Open Source

- Solve your own problems
- See how it all works
- Collaborate / contribute
- Available now and forever
- Affero GPL (reciprocal)
- Dual licensing available
- <https://proj.goldencode.com/p2j>

The logo for FWD, featuring the letters 'FWD' in a bold, blue, sans-serif font. The letters are set against a yellow, stylized triangular shape that resembles a play button or a forward-pointing arrow.

Find Us On the Web!



www.beyondabl.com



facebook.com/beyondabl



twitter.com/beyondabl



plus.google.com/+beyondabl



linkedin.com/company/fwd-project



[youtube.com/channel/
Uck3pga7EKxAQVOV_CiYOR7g](https://youtube.com/channel/Uck3pga7EKxAQVOV_CiYOR7g)